

Universal Controllers



RWD68U Universal Controller.

Description

The RWD family of Universal Controllers are intended for heating, air conditioning, ventilation and refrigeration in comfort control applications.

Applications

RWD62U/68U/82U main loop control applications are designed for temperature, static pressure, humidity, air pressure, fluid pressure, refrigeration, air quality and air fluid velocity control. The controller contains pre-programmed applications.

Auxiliary control functions include:

- Day/night set points
- Remote set point control
- Limiter control
- Cascade control
- Maximum priority
- Set point compensation
- Summer/winter operation

Control parameters are adjusted for maximum comfort control via three buttons on the face of the device, or with a laptop computer and Siemens Building Technologies program software.

Features

RWD62U/68U

- Stand-alone electronic temperature controller with P or P+I response
- 24 Vac operating voltage
- Control application selectable via Application Number
- Active input scale can be selectable
- Limit and direction of the output scale can be freely assigned
- Two universal inputs for Siemens 1000 Ohm nickel (Ni 1000), 1000 Ohm platinum (Pt 1000) temperature sensors and 0 Vdc to 10 Vdc signals
- Unit can be set as °F, °C, % or no specified unit
- Two modulating 0 to 10 Vdc signal outputs, direct or reverse action
- One digital input for day/night changeover
- Entering or changing of all data via operating buttons on the controller, possible without additional tools
- PC connection for downloading canned applications via the software tool

RWD82U

- Stand-alone electronic temperature controller with P or PI response
- 24 Vac operating voltage
- Control application selectable via Application Number
- Active input scale can be selectable
- Two universal inputs for Siemens 1000 Ohm nickel (Ni 1000), 1000 Ohm platinum (Pt 1000) temperature sensors and 0 Vdc to 10 Vdc signals
- Unit can be set as °F, °C, % or no specified unit
- One three-position, floating output or two two-position outputs, direct or reverse action
- One digital input for day/night changeover
- Entering or changing of all data via operating buttons on the controller, possible without additional tools
- PC connection for downloading canned applications via the software tool

Specifications/Product Ordering

General

Power Supply

Operating voltage 24 Vac + 20%
 Frequency 50/60 Hz
 Power Consumption 3.5 VA

LCD Actual and Nominal Values Four Digits

Set Point Adjustment Range -58°F to +302°F (-50°C to +150°C)

Display Resolution (Does Not Relate to Controller Accuracy)

Siemens Ni 1000 Ohm 1°F (0.5°C)
 Pt 1000 Ohm 1°F (0.5°C)
 Active Sensor Depends on Setting Range

Environmental Conditions

Storage and Transport
 Temperature -13°F to +158°F (-25° to +70°C)
 Humidity <95% RH
Operation
 Temperature 32°F to 122°F (0°C to 50°C)
 Humidity <95% RH

Regulatory Approvals Conforms to CE Requirements
 UL 916 Energy Management Equipment

Terminals Screw Terminals for Cables with
 min. 20 AWG; Max. 2 x16 or 1 x 14 AWG

Shipping Weights

RWD62U 10.4 oz. (295 grams)
 RWD68U 10.72 oz. (304 grams)
 RWD82U 11.12 oz. (315 grams)

Analog Inputs

..... x1, x2 Siemens Ni 1000 Ohm @ 32°F (0°C)
 Controller Measuring Range -58°F to +302°F (50°C to 150°C)
 Maximum Cable Length for 14 AWG 984 ft. (300 m)

Pt 1000 Ohm at 32°F (0°C)

Controller Measuring Range -4°F to +356°F (-20°C to +180°C)
 Maximum Cable Length for 14 AWG 984 ft. (300 m)

Analog Voltages (For Measured Variable in °F, °C, % or Without Unit)

Range 0 to 10 Vdc corresponding to
 adjustable range from -100 to
 8000 (°F, °C, % or no unit)
 Maximum Cable Length for 14 AWG 984 ft. (300 m)

Remote Set Point x2

Range 0 to 1000 Ohm Corresponding to
 Adjustable Range from -100 to
 8000 (°F, °C, % or No Unit)
 Maximum Cable Length for 14 AWG 984 ft. (300 m)

Inputs and Outputs

RWD62U/68U/82U

Digital Input D1
 Polling Voltage for Control Commands (D...M) 15 Vdc
 Current Consumption <15 mA

RWD68U

Analog Outputs Y1, Y2
 Range 0 to 10 Vdc
 Maximum Current +1 mA
 Digital Output (Q1)
 Relay Contacts (potential-free)
 Voltage 24 Vac to 230 Vac
 6A Res/5A Ind/5 FLA/ 30 LRA/
 1/2 HP
 30 Vdc, 4A

RWD82U

Digital Outputs Q1, Q2
 Relay Contacts (potential-free)
 Voltage 24 Vac to 230 Vac
 6A Res/5A Ind/5 FLA/ 30 LRA/
 1/2 HP
 30 Vdc, 4A

► Sensors for this product can be found on pages B-21, B-25, B-35, and B-43.

RWD Universal Controllers	Outputs		Operating Voltage	Part Number
	0 to 10 Vdc	Digital		
	2	–	24 Vac	RWD62U
	1	1	24 Vac	RWD68U
	–	2	24 Vac	RWD82U



RWD Controller and Enclosure

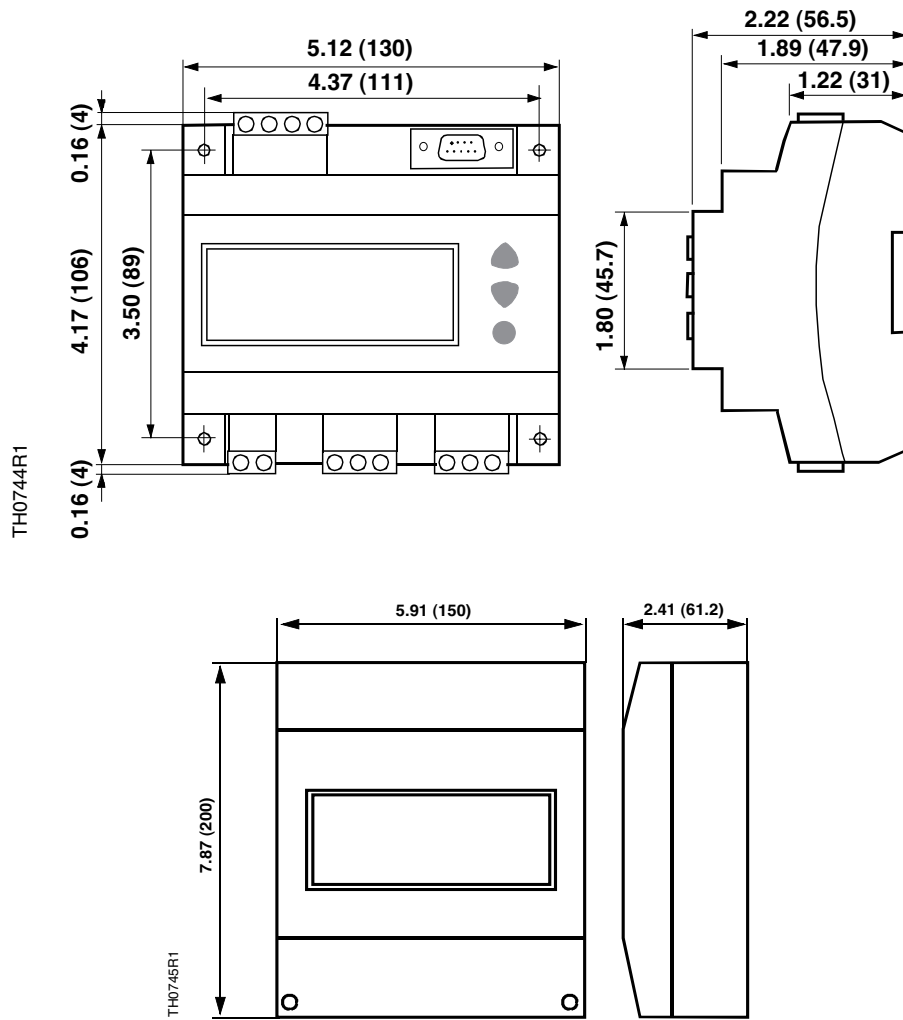

Dimensions shown in inches (mm).

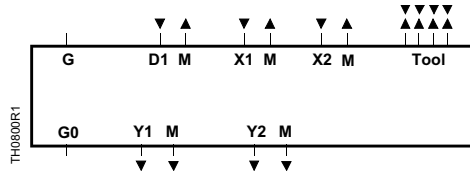

RWD62U.

Key

- | | | | |
|--------------|---|---------------|--|
| D1 | Digital input | x2 | Signal input (aux. Input: Siemens Ni1000, Pt 1000, 0 to10 Vdc and 0 to 1000 Ω or 0 to 10 Vdc remote set point) |
| G, G0 | 24 Vac supply | Y1, Y2 | Analog outputs |
| M | Ground (G0) for signal inputs and universal inputs and analog outputs | Tool | Communication port for PC (9-pin plug) |
| x1 | Signal input (main input: Siemens Ni 1000, Pt 1000 and 0 to10 Vdc) | | |

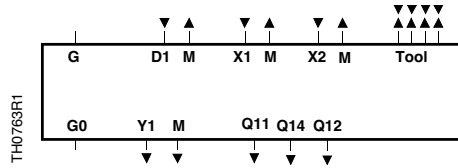

RWD68U.

Key

- | | | | |
|-----------------|---|---------------|--|
| D1 | Digital input | x1 | Signal input (main input: Siemens Ni 1000, Pt 1000 and 0 to10 Vdc) |
| G, G0 | 24 Vac supply | x2 | Signal input (aux. Input: Siemens Ni1000, Pt 1000, 0 to10 Vdc and 0 to 1000 Ω or 0 to 10 Vdc remote set point) |
| M | Ground (G0) for signal inputs and universal inputs and analog outputs | Y1, Y2 | Analog outputs |
| Q11, Q21 | NC Contact | Tool | Communication port for PC (9-pin plug) |
| Q12, Q22 | Neutral | | |
| Q14, Q24 | NO Contact | | |

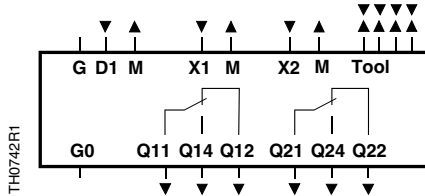

RWD82U.

Key

- | | | | |
|--------------|---|---------------|--|
| D1 | Digital input | x1 | Signal input (main input: Siemens Ni 1000, Pt 1000 and 0 to10 Vdc) |
| G, G0 | 24 Vac supply | x2 | Signal input (aux. Input: Siemens Ni1000, Pt 1000, 0 to10 Vdc and 0 to 1000 Ω or 0 to 10 Vdc remote set point) |
| M | Ground (G0) for signal inputs and universal inputs and analog outputs | Y1, Y2 | Analog outputs |
| Q11 | Common for digital contact | Tool | Communication port for PC (9-pin plug) |
| Q12 | NC Digital Contact | | |
| Q14 | NO Digital Contact | | |

Temperature Controllers (Heat Pumps)



RWD44U Temperature Controller.

Description

The RWD Family of Temperature Controllers are standalone, electronic, programmable controllers with pre-configured temperature control applications. The Temperature Controllers are intended for heating, ventilating, and air conditioning systems, including one, two or three-stage compressors, heat pumps or single or dual stage heating and/or cooling equipment. The 24 Vac operating voltage controller switches four on/off outputs and has two universal inputs for Siemens Nickel 1000, Platinum 1000 or active 0 Vdc to 10 Vdc signals.

features

- Standalone electronic controller with pre-configured applications
- Two or three universal inputs for Ni1000, Pt1000 or active 0 to 10 Vdc sensors
- Four 2-position (On/Off) outputs (RWD45) and one modulating 0 to 10 Vdc output (RWD45)
- Modulating 0 to 10 Vdc for economizer or second independent control loop (RWD45)
- Suitable for 1, 2, or 3-stage compressors
- Adjustable compressor delay times
- Keypad is used to enter or change data- No need for tools
- Download pre-programmed applications via software tool using PC connection

Applications

The RWD45U Controller is intended for HVAC systems, including heat pumps:

- Single, dual or triple compressor heat pump units
- Single or dual stage heating and cooling equipment
- Single or dual stage cooling equipment
- Single or dual stage heating equipment
- Equipment with 0 to 10 Vdc input

Universal input X2 are used for the following auxiliary functions:

- On/Off (standby)
- Remote set point
- Alarm
- Filter alarm
- Set point compensation
- Sensor averaging
- Winter/Summer set point changeover
- Sensor selection

Universal input X3 are used (RWD45U) for the following functions:

- Economizer sensor
- Second, independent sensor

Specifications/Product Ordering

General

Power Supply

Operating Voltage 24 Vac \pm 20%
 Frequency 50/60 Hz
 Power Consumption 4.0 VA

LCD

Actual and Nominal Values Maximum Four Digits
 Display Resolution (not related to controller accuracy)
 Ni 1000 Ω 1.0°F (0.5°C)
 Pt 1000 Ω 1.0°F (0.5°C)
 Active Sensor Depends on Setting Range

Environmental Conditions

Storage and Transport

Temperature -13 to +158°F (-25 to +70°C)
 Humidity <95% RH

Operation

Temperature 32 to 122°F (0 to 50°C)
 Humidity <95% RH

Regulatory Approvals

Housing NEMA 1
 CE Conforms to CE Requirements
 UL UL Listed to 916

Terminals

Screw Terminals for Cables
 with min. 20 AWG; Max. 2 x 16 or 1 x 14 AWG

Shipping Weight

RWD44U 0.75 lb. (0.300 kg)
 RWD45U 11.64 oz. (0.320 kg)

Inputs and Outputs

RWD44

Analog Inputs x1, x2

(Siemens Ni 1000 Ω at 32°F [0°C])
 Controller Set Point Range -58 to +302°F (-50 to +150°C)
 Maximum Cable Length for 14 AWG 984 ft. (300 m)

Pt 1000 Ω at 32°F (0°C)

Controller Set Point Range 4 to 356°F (-20 to +180°C)
 Maximum Cable Length for 14 AWG 984 ft (300 m)

Analog Voltages (for measured variables in °F, °C, % or without unit)

Range 0 to 10 Vdc Corresponding to
 Adjustable Range from -100 to +2400
 Max. Cable Length for 14 AWG 984 ft. (300 m)

Remote Set Points x2 (for measured variables

in °F, °C, % or without unit)

Range 0 to 10 Vdc Corresponding to
 Adjustable Range from -100 to +2400
 Max. Cable Length for 14 AWG 984 ft. (300 m)

Digital Input D1

Polling Voltage for Control Commands (D – M) 15 Vdc
 Current Consumption <10 mA

Digital Output Q1 through Q4

Relay Contacts (potential-free)

Voltage 24 Vac
 Maximum Rating 24V to 230V, 5A Res/5 FLA/30LRA/
 1/2 HP
 Minimum Rating 19.2 Vac, 20 mA
 5 Vdc, 100 mA

RWD45

Analog Inputs x1, x2, x3

1000 Ohm at 32°F (0°C)

Controller Set Point Range -58 to +302°F (-50 to +150°C)
 Maximum Cable Length for 14 AWG Maximum 984 ft. (300 m)

Analog Inputs x1, x2, x3

Pt 1000 Ohm at 32°F (0°C)

Controller Set Point Range -58 to +302°F (-50 to +150°C)
 Maximum Cable Length for 14 AWG Maximum 984 ft. (300 m)

Analog Voltages (for measured variables in °C, % or without unit)

Range 0 to 10 Vdc Corresponding to
 Adjustable Range from -100 to +2400
 Maximum Cable Length for 14 AWG Max. 984 ft. (300 m)

Remote Setpoint x2

Range 0 to 1000 Ohm Corresponding to
 Adjustable Range from -100 to +2400
 Max. Cable Length for 14 AWG (°F, °C) 984 ft. (300 m)

Digital Input D1

Polling Voltage for Control Commands (D – GND) 15 Vdc
 Current Consumption <10 mA

Analog Output Y1

Range 0 to 10 Vdc
 Maximum Current \pm 1 mA

Digital Output Q1 through Q4

Relay Contacts (potential-free)

Voltage 24 to 230 Vac
 Maximum Rating 5A Resistive, 5 FLA
 30 LRA/1/2 HP
 30 Vdc, 4A
 Minimum Rating 19.2 Vac, 20 mA
 5 Vdc, 100 mA

► Sensors for this product can be found on pages B-21, B-25, B-35, and B-43.

RWD Temp Controllers	Inputs		Output Two-position	Operating Voltage	Part Number
	0 to 10 Vdc	Digital			
	2	1	4	24 Vac	RWD44U
	3	1	4	24 Vac	RWD45U



RWD Controller and Enclosure

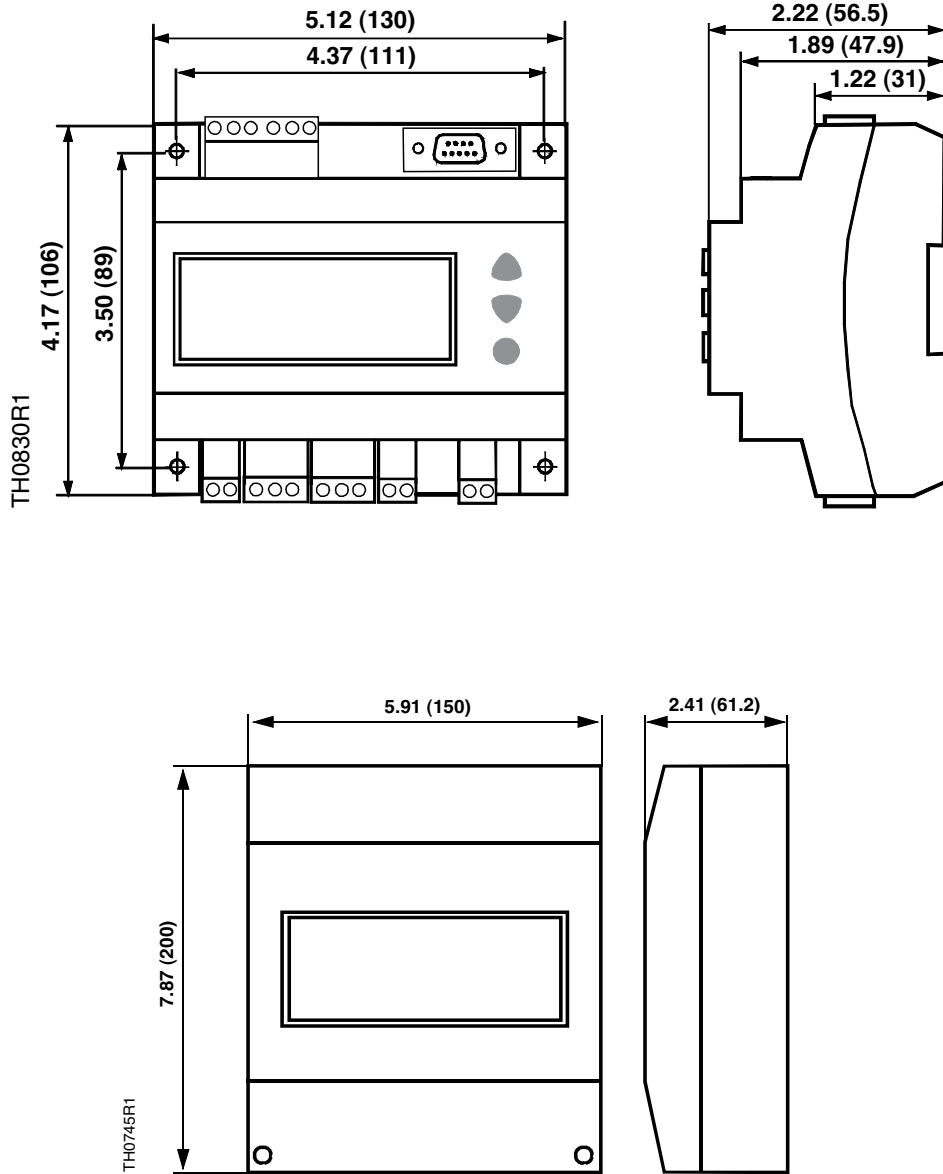

Dimensions shown in inches (mm).

Wiring Diagrams

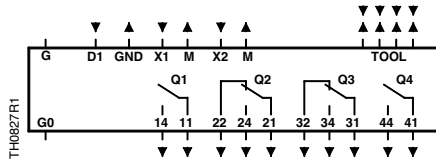

RWD44U.

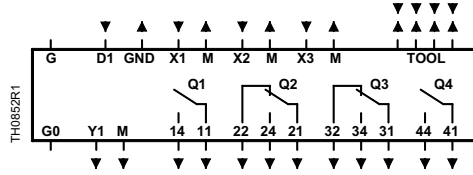

RWD45U.

Key

- D1 Digital input
- G, G0 24 Vac supply
- M Ground (G0) for signal inputs
- Q1-Q4 Relay outputs; various voltages permissible
- x1 Signal input (Main Input: Siemens Ni 1000, Pt 1000 and 0-10 Vdc)
- x2 Signal input (Aux. Input: Siemens Ni 1000, Pt 1000 and 0-10 Vdc)
- x3 Signal input (Eco. Sensor or second ind. Input: Siemens Ni 1000, Pt 1000 and 0-10 Vdc)
- Y1 Analog output (0 to 10 Vdc)
- Tool Communication port with PC (9 pin plug)

Note

M, GND and G0 are internally connected.

Time Clock



Time Clock for RWD Temperature Controllers.

Description

The digital Time Clock is used to switch an HVAC system on and off, or for the control of setback periods at night and weekends.

Function

The microprocessor automatically stores the programmed times in chronological order. The time clock operates in one of four modes:

- Manual, continuously On
- Manual, continuously Off
- Adjustable Countdown Timer On
- Automatically via the time program

A momentary contact close switch across M and D1 activates the Countdown Timer. The power supply is buffered by a memory back-up capacitor. In the event of a power failure, the clock will continue to run, with the program retained, for 72 hours. However, the output will go to (or remain in) the normal position.

- Integrated countdown timer for after-programmed-hours operation
- Countdown timer only option
- Suitable for mounting on DIN rails
- Simple programming with large, clear LCD
- Manual on/off control
- Quick Daylight Savings time (DS) adjustment
- Power reserve of 72 hours

Wiring Diagram

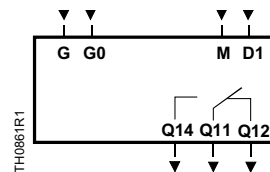

Time Clock.

- G, GO** 24 Vac input
- M, D1** Digital input (momentary close switch)
- Q...** Digital output (24 Vac to 240 Vac).

CAUTION: Do not connect external power to terminals M, D1.

Specifications/Product Ordering

Power Supply

Operating Voltage..... 24 Vac, -15 to +10%
 Frequency 50 Hz/60 Hz
 Power Consumption 3.0 VA

Ambient Conditions

Operation 32°F to 122°F (0°C to 50°C)
 Storage..... -13°F to +158°F (-25°C to +70°C)
 Humidity < 95% RH
 General For Internal Use, in Control Panels, etc.

Regulatory Approvals

UL UL Listed to 916
 cUL CSA C22.2 No. 205-M1983

Color

Housing Top Light Gray
 Housing Bottom..... Silver Gray

Mounting

..... Snap-mounted on a Rail or Screwed to a Flat Surface

Terminals

Screw Terminals for Cables with Min. 20 AWG; Max. 2 x 16 or 1 x 14 AWG

Shipping Weight 0.66 lb. (0.3 kg)

Dimensions 3.07" H x 4.17" W x 2.20" D
 (78 mm H x 106 mm W x 56 mm D)

Digital Input D1

Polling Voltage for Control Commands (D to M) 24 Vdc
 Current Consumption 8 mA

Digital Output Q

Relay Contacts (potential-free)
 Voltage 24 Vac to 240 Vac
 Contact Rating..... 6A Resistive, 5 FLA, 30 LRA

Time Clock

Time Basis..... Quartz
 Memory Locations 8 for 7-day Clock, with Grouping into 12 Blocks for 24-hour Clock
 Power Reserve..... Nominal 72 hours, after 24 hours of Operation
 Accuracy ±1 second/day @ 68°F (20°C)
 Display 1.5 in (40 mm) LCD
 Maintenance..... Not Required

	Description	Part No.
RWD	Time Clock	SEH62.1U



Dimensions

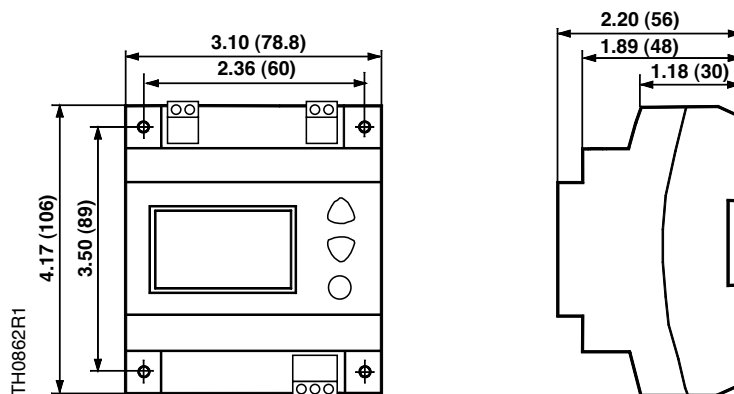

Dimensions shown in inches (mm).



RWD Transformer.

Description

The SEM62.2U Transformer reduces voltage from 120 Vac to 24 Vac.

Applications

This power Transformer (with housing) reduces a 120 Vac supply voltage to the 24 Vac supply voltage required by controllers. The transformer has output power ratings of 30 VA, and an integral self-resetting fuse on the primary side that protects the transformer from overheating. It includes an on/off switch with replaceable fuse, which eliminates the need for additional 24V circuit on/off switch and fuse (or circuit breaker).

features

- Output power 30 VA
- Suitable for mounting on DIN rails
- Secondary power supply indication via LED
- Integral self-resetting primary fuse
- Secondary power supply on/off switch with replaceable fuse

Wiring Diagram

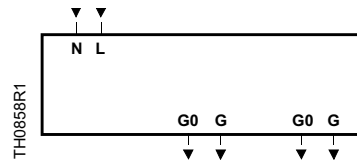

Transformer.

N, L 120 Vac input
G, G0 24 Vac output

Note: Total transformer output power is 24 VA. Two sets of G0 and G terminals are provided to enable easier wiring.

Specifications/Product Ordering

Input Power Supply

Voltage 120 Vac, 0.4A
 Frequency 60 Hz

Output

Voltage 30 Vac
 Total Output Power 24 VA
 Fuse Rating Time Delay 1.6A
 Fuse Dimension 5 mm x 20 mm Glass Type

Ambient Conditions

Operation 32 to 122°F (0 to 50°C)
 Storage -13 to +158°F (-25 to +70°C)
 Humidity Maximum 65% RH, Non-condensing
 General For Internal Use, in Control Panels, etc.

Regulatory Approvals UL Listed to 916
 CSA
 C22.2 No. 205-M1983

Terminals Screw Terminals for Cables
 with min.20 AWG; Max. 2 x 16 or 1 x 14 AWG

Shipping Weight (including packaging) 2 lb. (0.910 kg)

Dimensions 4.48" W x 4.17" H x 2.22" D
 (113.8 mm W x 106 mm H x 56.4 mm D)

Mounting Snap-mounted on a Rail or Screwed to a Flat Surface

Orientation Any

	Description	Part No.
RWD	Transformer for RWD	SEM62.2U



Dimensions

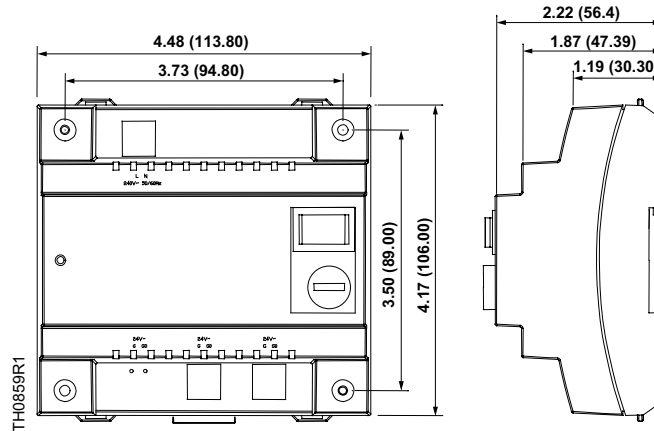

Dimensions shown in inches (mm).